

---

Xibu

PAPERBOX

PAPERBOX vacuum hybrid

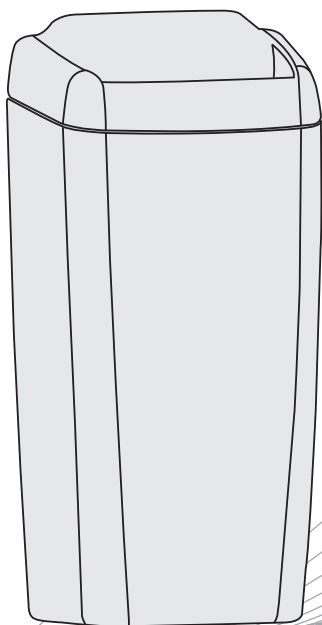

# Xibu PAPERBOX

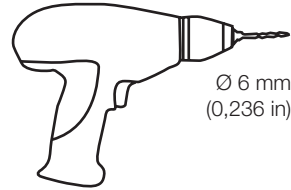
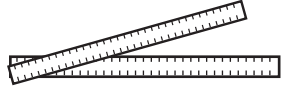
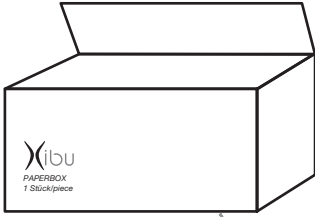

Ø 6 mm  
(0,236 in)

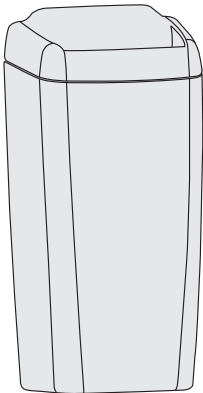

1 x



1 x



2 x



2 x

# Xibu PAPERBOX vacuum hybrid

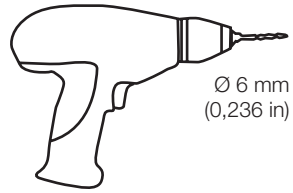
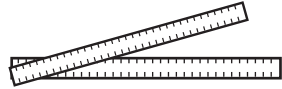
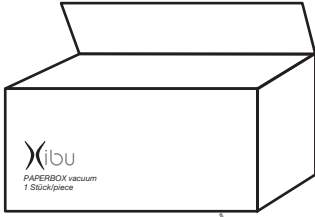

Ø 6 mm  
(0,236 in)



D-Type  
(mono/LR20/13A)  
ALKALINE

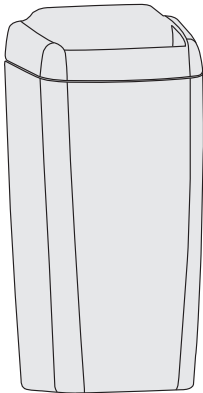

1 x



1 x



2 x





2 x

## FOR THE UNITED STATES ONLY

### General Safety Information

The following symbols and headings are used throughout this manual to indicate possible hazards to persons or equipment. The symbols and headings are shown in order of importance. For efficient and safe operation, be sure to follow the installation and operating instructions provided in this manual. In particular, all safety symbols and notices must be followed.

 <b>WARNING</b>	Indicates a potentially hazardous situation which, if not avoided, could result in serious injury or death.
 <b>CAUTION</b>	Indicates a potentially hazardous situation which, if not avoided, could result in minor personal injury.
<b>NOTICE</b>	This safety warning indicates possible hazards to the product or to other equipment.
<b>IMPORTANT</b>	Vital information or tips for the installer or operator.

### General Safety Instructions

 <b>CAUTION</b>	<p><b>When installing any equipment, ensure that all national and local safety, electrical and plumbing codes are met.</b></p> <p><b>When using electrical appliances, basic safety precautions should always be followed.</b></p> <p><b>Always wear safety goggles to protect your eyes and wear other appropriate safety items for protection to avoid injury when drilling.</b></p>
---	--

### IMPORTANT

- Do not mix old and new batteries. Always remove exhausted batteries and dispose safely.
- Americans with Disabilities Act: Title III of the Americans with Disabilities Act (ADA) governs, in detail, the placement and operation of dispensers. You should ensure that your mounting and use of dispensers complies with that law as well as the regulations issued under that statute. The mounting suggestions in this document may or may not fulfill the obligations of the ADA with respect to your facility.

1.

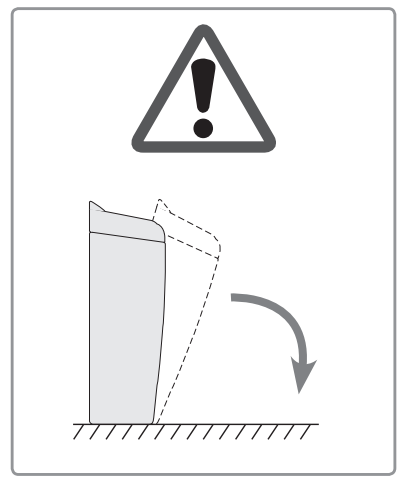
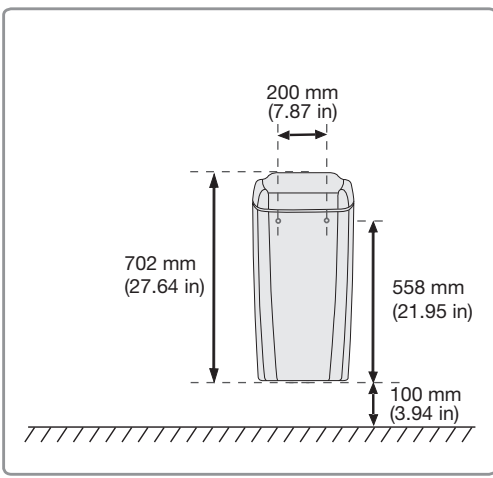

2.

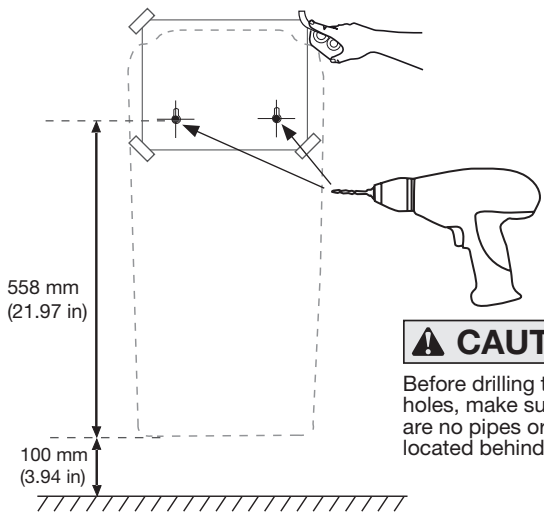

**CAUTION**

Before drilling the holes, make sure there are no pipes or wires located behind the wall

3.

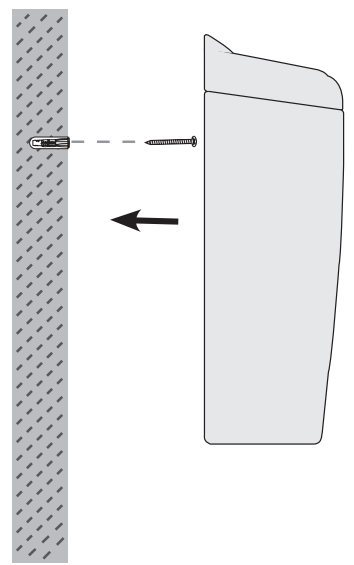

4.

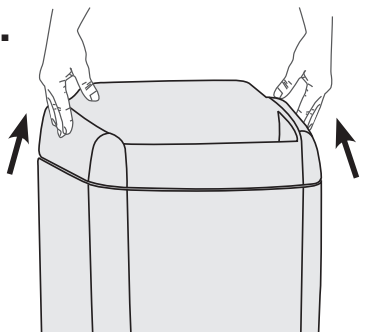

5.

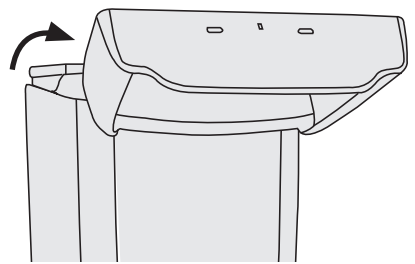

6.

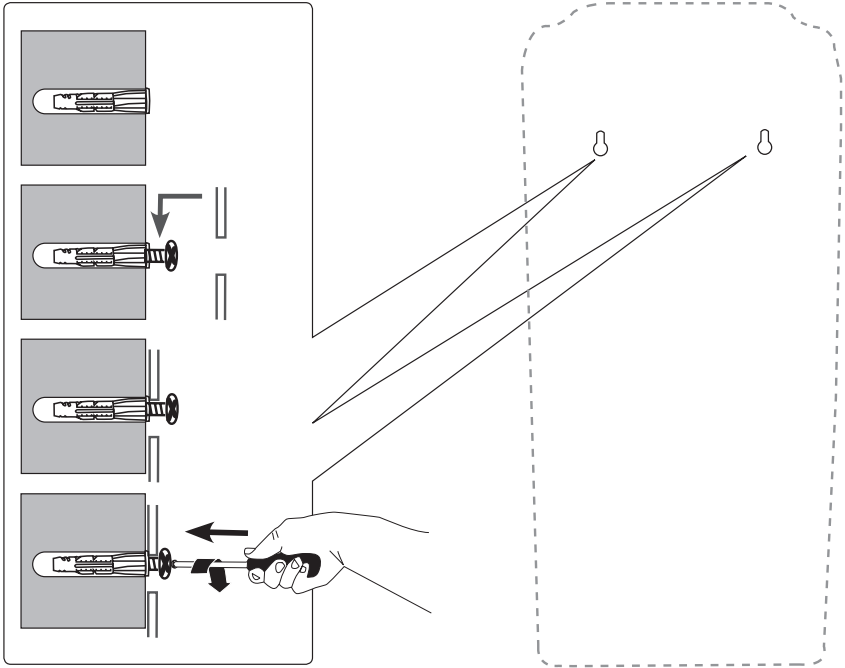

7.

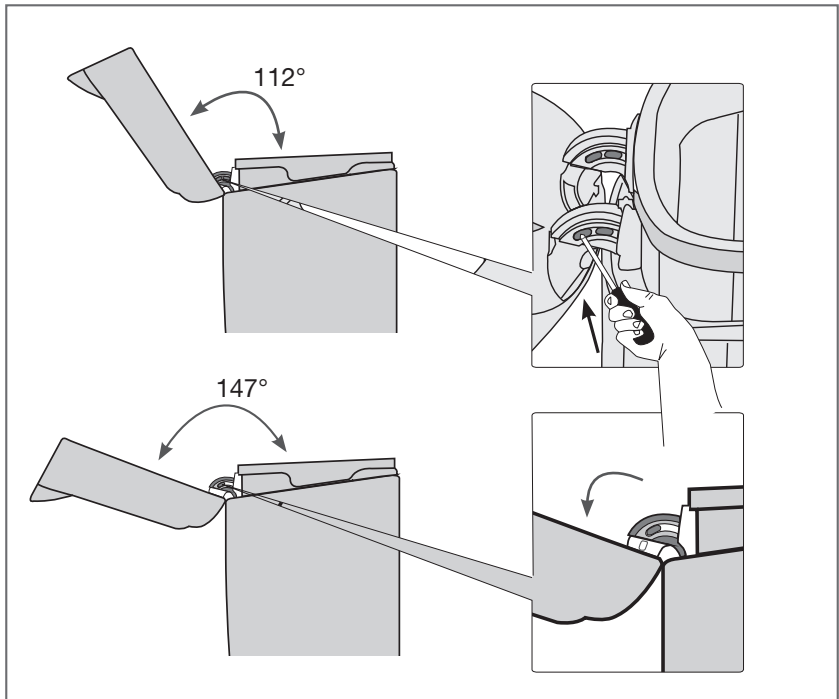

# 8. Filling

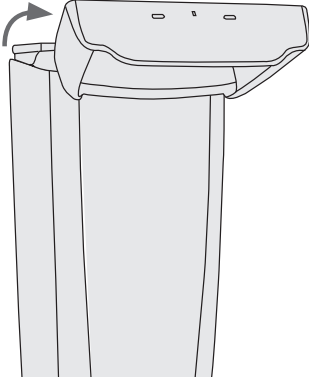

# 9.

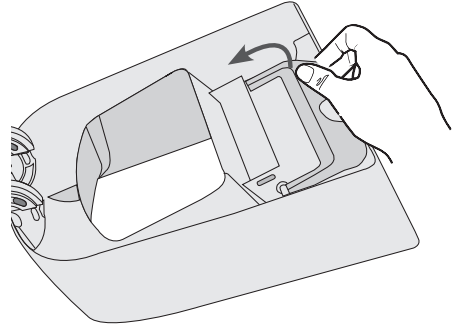

# 10.

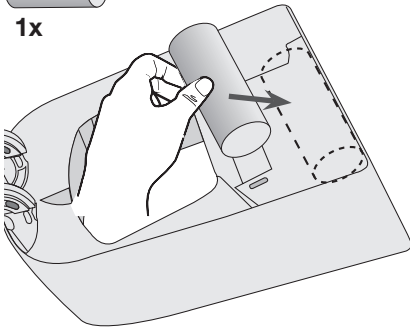

# 11.

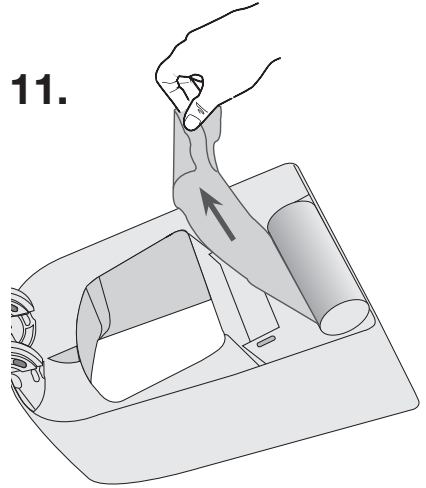

# 12.

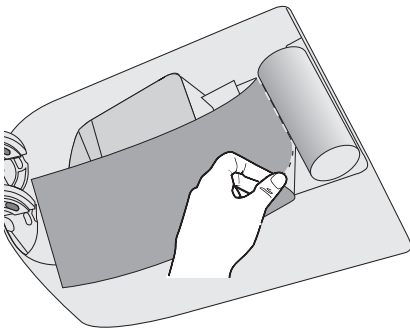

# 13.

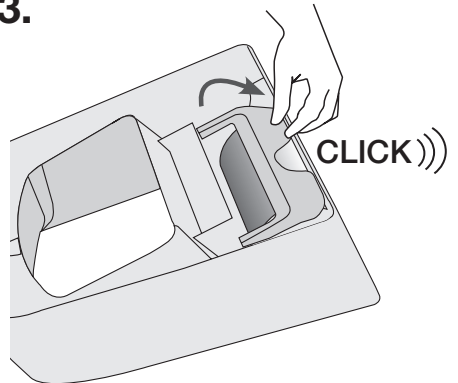

14.

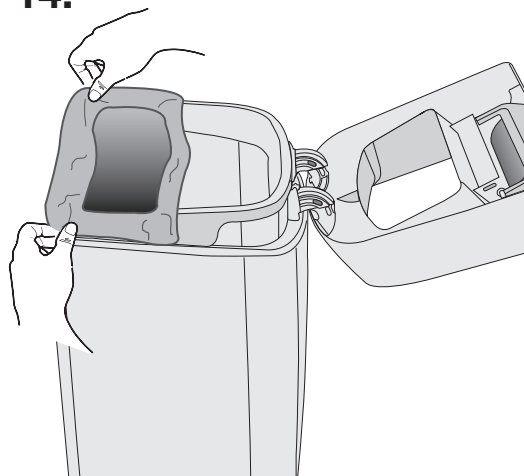

15.

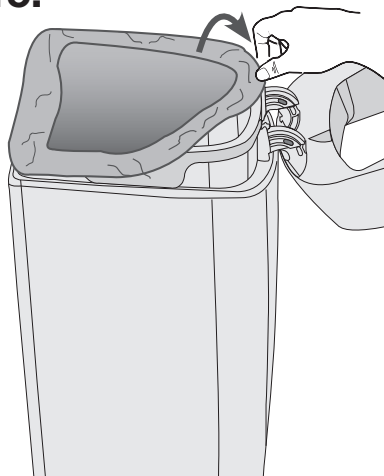

16.

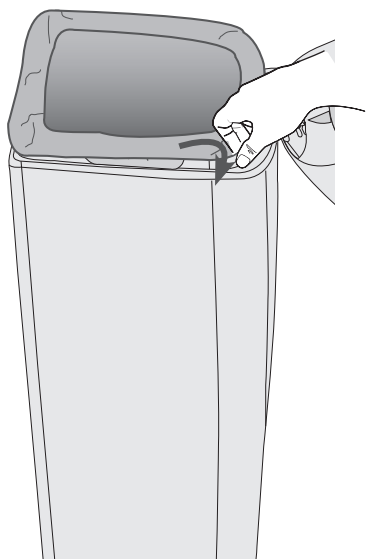

17.

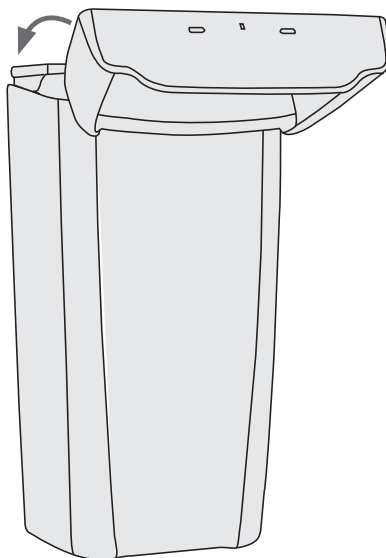



## Option

add hybrid for PAPERBOX

XIBU PAPERBOX vacuum hybrid

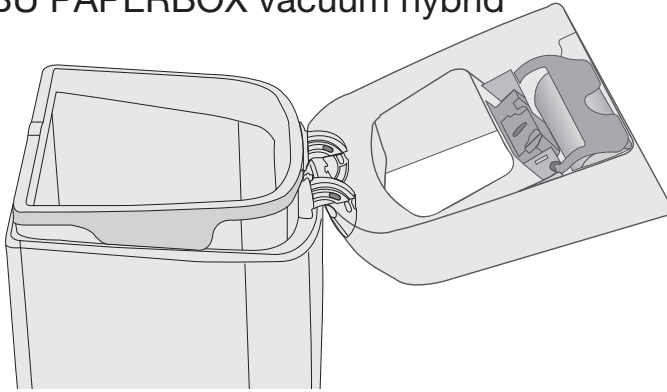

Please follow this link for further instructions:

[https://cdn.hagleitner.com/fileadmin/user\\_upload/shop\\_rsync/banleitung/2020/BAL\\_LEVEL\\_UNIT\\_hybrid\\_20201120.pdf](https://cdn.hagleitner.com/fileadmin/user_upload/shop_rsync/banleitung/2020/BAL_LEVEL_UNIT_hybrid_20201120.pdf)

## 18.

XIBU PAPERBOX

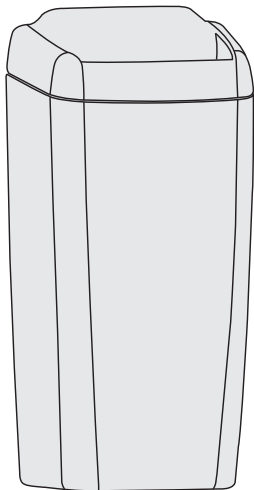

XIBU PAPERBOX vacuum hybrid

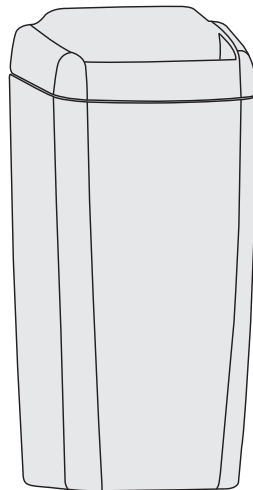

see following instructions

# Xibu PAPERBOX vacuum hybrid

19.

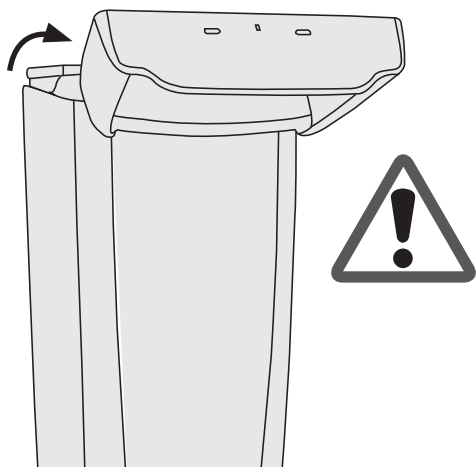

20.

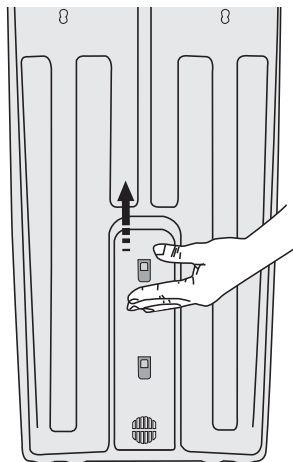

21.



D-Type  
(mono/LR20/13A)  
ALKALINE

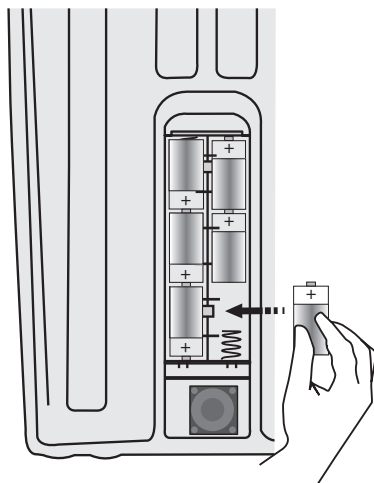

22.

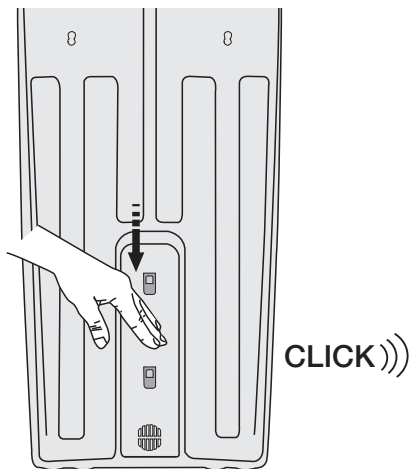

23.

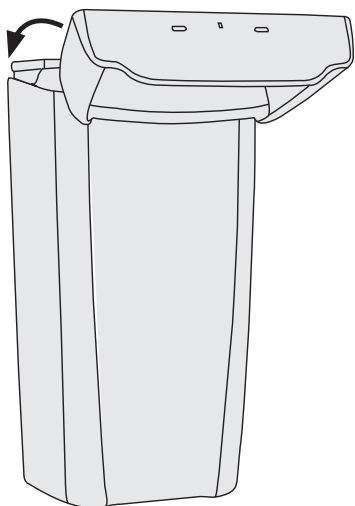

24.

